

Hunter®

DESIGN GUIDE

Residential Sprinkler System

RESIDENTIAL & COMMERCIAL IRRIGATION
Built on Innovation®



TABLE OF CONTENTS

Sprinkler System Planning

- 3 Plot, Plan and Design

Sprinkler System Capacity

- 4 Determine System Design Capacity

Selecting Sprinklers

- 6 Select Sprinkler Heads
- 8 Draw Sprinkler Head Locations

Sprinkler Zones

- 9 Divide Sprinklers Into Zones
- 9 Indicate Zones

Valves and Pipes

- 10 Locate Valves – Layout and Size Pipes
- 10 Lateral Line

Point of Connection

- 11 Main Line
- 11 Point of Connection

Sprinkler System Overview

- 12 Overview Illustration

System Installation

- 14 Making the Point of Connection
- 14 Installing the Main Line
- 15 Installing the Valve Manifolds
- 15 Installing the Lateral Lines
- 16 Installing the Controller
- 16 Installing Sprinkler Heads
- 16 Backfilling
- 17 Weather-Based Sensors

Materials List

- 18 Point of Connection (Interior/Exterior)
- 19 Pipes
- 20 Control Valves
- 21 Controller/Weather-Based Sensors
- 22 Sprinklers

Watering Guideline

- 24 Application Rates
- 24 Watering Guidelines
- 24 Freezing Areas
- 24 Choosing Sprinkler Nozzles

Parts Ordering List / Glossary of Terms

- 25 Parts Ordering List 27 Glossary of Terms

INTRODUCTION

This booklet is intended to be used when designing and installing small single family residential sprinkler systems. It is set up in an easy-to-follow format with illustrations and helpful charts.

If this is the first irrigation system you have installed, or if you have installed several systems but have never used this guide before, we recommend you review this design guide and become familiar with the design and installation process.

There are detailed illustrations depicting suggested installation methods for sprinkler heads, pipe and valve manifolds, and how to connect the sprinkler main line into the house water system. Installation tips have also been placed throughout the guide to assist you in planning a system. While developing the flow, working pressure, and pipe sizing charts, we considered reasonable friction loss and acceptable water velocity for a residential irrigation system. If you have any questions on the design or installation process, your best resource is your local Hunter distributor.

Hunter recommends contracting the services of a professional irrigation designer when planning large residential or commercial projects. Contractors and irrigation designers can receive additional information by contacting their local Hunter distributor.

The use of high efficiency MP Rotators with pressure regulated pop-up bodies like the PRS40 will maximize water savings. Also, consider the use of a weather-based sensor to continually adjust watering times based on the current weather to maximize water savings.

Reference Hunter's residential/commercial catalog for products and performance charts, and Hunter's support page for technical support at:



hunterindustries.com/catalog
hunterindustries.com/support

SPRINKLER SYSTEM PLANNING

Plot, Plan, and Design

1. The first step in designing a residential system is to measure the property and indicate the location of the house. On a separate piece of paper sketch out your property and place your measurements on the sketch. Be sure to include all concrete or brick walks and patios, driveways, and fences. While you are measuring, locate any trees, shrubs, and lawns and draw them on the sketch.
2. Next, draw the plot plan to scale on a graph paper. The scale can be 1"=10', 1"=20', or whatever you decide. Write your scale on the plan. Make sure to note lawn, shrub, ground cover, and large trees.
3. On the plot plan, divide the property into areas. Consider the information in Step 2 while dividing up the plot plan: front yard, back yard, side yard, lawn or shrub areas, and shady areas. Label your areas A, B, C, D, etc.
See the example plot plan below.

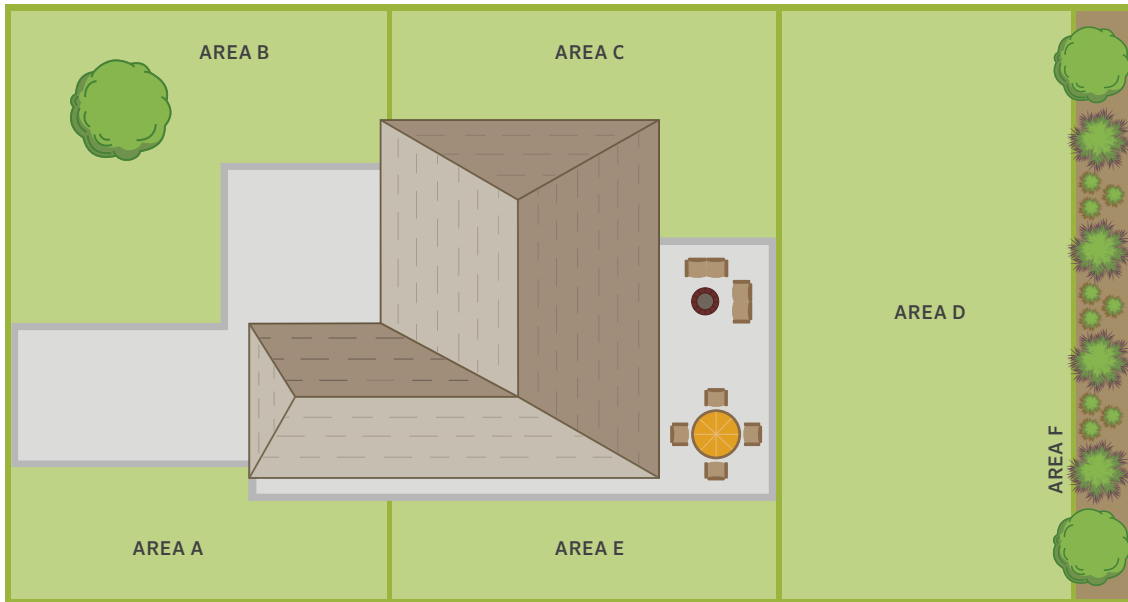

TOOLS AND SUPPLIES YOU MIGHT NEED	
Permit (As required by local/city laws)	Spray Marking Paint
Small Irrigation Flags	Tape Measure
Hack Saw	Trencher or Pipe-Puller
Hammer	Tunnel Kit or Hose Jetting Kit
Pipe Wrenches	Wire Cutters
Plastic Tarp	Insulated Wire Staples
Pliers	Rain Shut-off Device / Weather Sensor
Rags	Shut-off Valves
Rake	Valve Boxes, 6" and 12"
Screwdriver	Teflon Tape (Used on all PVC or Poly thread-to-thread fittings)
Shovels - Trenching, Flat, Spade or Round Point	Automatic Drain Valve (Used in freezing climates to winterize system)

IF YOU USE PVC PIPE
Glue (Solvent)
Primer
PVC Pipe Cutters

IF YOU USE POLY PIPE
Pipe Clamps (for insert fittings only)

SPRINKLER SYSTEM CAPACITY

Determine System Design Capacity

When planning an efficient automatic irrigation system, you must first determine the correct Sprinkler System Design Capacity—how much water is available for residential irrigation. If the system will be installed using city water, follow the steps below. If the water will be drawn from a lake or well, your Hunter dealer or the pump installer will have the specifications for pressure and volume.

1. Water pressure (PSI)

To check the water pressure, attach a pressure gauge to the outside faucet closest to the water meter *Figure 1*. Make sure that no other water is flowing at the residence. Turn on the faucet and record the number on the first line in the right hand column below. This is the static water pressure in PSI.

2. Water volume (GPM)

To determine the volume of water available for the system, you need two pieces of information:

A. What size is the water meter?

The water meter will generally have the size stamped on the meter body. The most common sizes for residential meters are $\frac{5}{8}$ ", $\frac{3}{4}$ ", and 1". In some areas the water is connected directly to the city main without the use of the water meter. In these cases, simply enter the size of the service line in the space provided.

B. What size is the service line?

Measure the outside circumference of the pipe that runs from the city main to the house. An easy way to do that is to wrap a piece of string around the pipe, measure the string, and use the table to the right to convert the string length to pipe size.

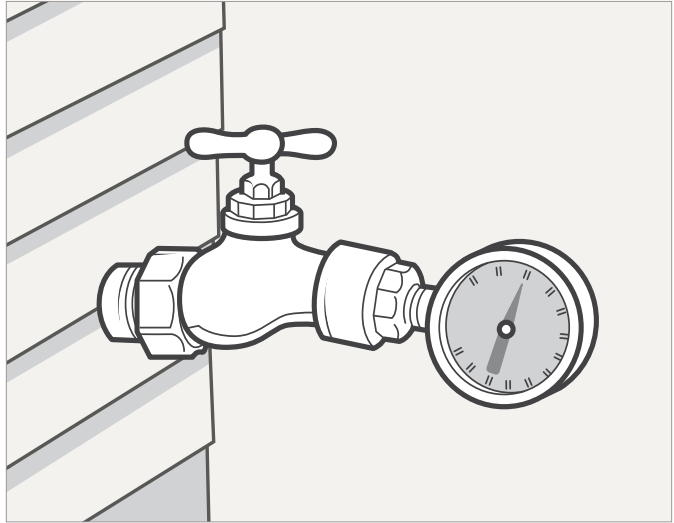

Figure 1: To check water pressure, attach a pressure gauge to the outside faucet nearest the water meter. A pressure gauge can be obtained from your local Hunter dealer.

Enter Static Pressure Here: _____

Enter the Size of the Meter Here: _____

Write the Service Line Size Here: _____

SERVICE LINE SIZE						
Approx. String Length	2¾"	3¼"	3½"	4½"	4¾"	5¼"
Copper Pipe	¾"		1"		1¼"	
Galvanized Pipe		¾"		1"		1¼"
PVC Pipe Size		¾"		1"		1¼"

SPRINKLER SYSTEM CAPACITY

3. System Design Capacity

- Using the System Design Capacity Chart to the right, locate the three numbers you just recorded to determine the Sprinkler System Design Capacity in gallons per minute (GPM). Record this number in the GPM box below.
- Next, locate your system's static pressure and move down that column and find the system's working pressure; record it in the PSI box below. Working pressure will be used when choosing sprinkler heads and designing the system.

You have now established the maximum GPM and the approximate working pressure available for the sprinkler system. Exceeding these maximums may result in inefficient watering or a condition referred to as water hammer, which could cause serious damage to the system. These two numbers will be used in the design process.

GPM	PSI
<input type="text"/>	<input type="text"/>
Design Capacity	Working Pressure

!
SYSTEM DESIGN CAPACITY EXAMPLE

- Water Meter 5/8"
- Service Line 1"
- Static Pressure 70 PSI

According to system design capacity

13 GPM	50 PSI
Design Capacity	Working Pressure

SPRINKLER SYSTEM DESIGN CAPACITY							
Static Pressure	PSI	30	40	50	60	70	80
WATER METER	SERVICE LINE	MAX GPM	MAX GPM	MAX GPM	MAX GPM	MAX GPM	MAX GPM
5/8"	1/2"	2	4	5	6	7	7
	3/4"	4	6	8	8	10	12
	1"	4	7	8	10	13	15
3/4"	3/4"	4	6	8	9	10	12
	1"	5	7	10	14	17	20
	1 1/4"	5	12	17	20	22	22
1"	3/4"	4	7	8	9	12	12
	1"	5	8	14	18	20	20
	1 1/4"	5	14	24	26	30	34

WORKING PRESSURE	PSI	25	30	35	45	50	55
------------------	-----	----	----	----	----	----	----

Note: Service lines are based on 100' of thick walled PVC. Deduct 2 GPM for copper pipe. Deduct 5 GPM for new galvanized pipe.

Working pressure is the approximate working pressure at the head, and should be used only as a guide when choosing the proper sprinkler heads and designing the system. The numbers in the Design Capacity Chart are based on generally accepted flow rates (velocity). In some cases, designers increase the velocity in copper pipe only from the accepted 7 1/2 feet per second (fps) to 9 feet per second (fps). If you do not deduct the 2 GPM for copper pipe, the rate is approximately 9 feet per second (fps). The friction loss is substantially increased at this velocity, and the working pressure will be affected. In order to use numbers in the chart, the length of copper service line should not exceed 50' if you decide not to deduct the 2 GPM.

SELECTING SPRINKLERS

Select Sprinkler Heads





There are three basic types of sprinklers for residential use: **large area rotors, rotating stream spray sprinklers, and small area fixed spray sprinklers.** Large area rotors and rotating stream spray sprinklers should never be installed on the same zone as small area fixed spray sprinklers. High efficiency spray nozzles such as MP Rotators® with PRS40 pressure regulated bodies should be considered in place of traditional fixed nozzles.

1. Large area rotors will cover areas that measure 25' by 25' and larger.
2. Small area rotating stream or spray sprinklers are typically used in areas smaller than 25' by 25'.

3. Micro irrigation delivers water right at the base of the plant through a system of flexible irrigation tubing, drip emitters, and micro sprays.

Within these groups are pop-up sprinklers which are installed even with the grade, and riser-mounted shrub heads, which are installed above grade. This 25' by 25' measurement is not a hard rule, rather it is a guideline. The only consideration restricting the size of the area in which spray heads (small area sprinklers) can be used is economics. If a large area rotor can be used, it usually means less pipe, fewer valves, and a smaller controller will be required to complete the job.

ROTORS

	PGJ	SRM	PGP®-ADJ	PGP-ULTRA	I-20
					
Radius (ft)	15'-37'	15'-30'	22'-52'	17'-46'	17'-46'
Flow (GPM)	0.64-5.3	0.42-3.4	0.5-14.1	0.36-14.8	0.36-14.8
Inlet Size	½"	½"	¾"	¾"	¾"

NOZZLES

	MP ROTATOR	MP ROTATOR SR SERIES	PRECISION DISTRIBUTION CONTROL™	PRO FIXED	SPECIALTY	BUBBLERS
						
Radius (ft)	8'-35'	6'-12'	4'-17'	5'-17'	Variable/Fixed	1'-1.5'

SPRAY BODIES

	PS ULTRA	PRO-SPRAY®	PRS30	PRS40
				
Models (in)	2, 4, 6	Shrub, 2, 3, 4, 6, 12	Shrub, 4, 6, 12	Shrub, 4, 6, 12
Pressure Regulation	—	—	30 PSI	40 PSI



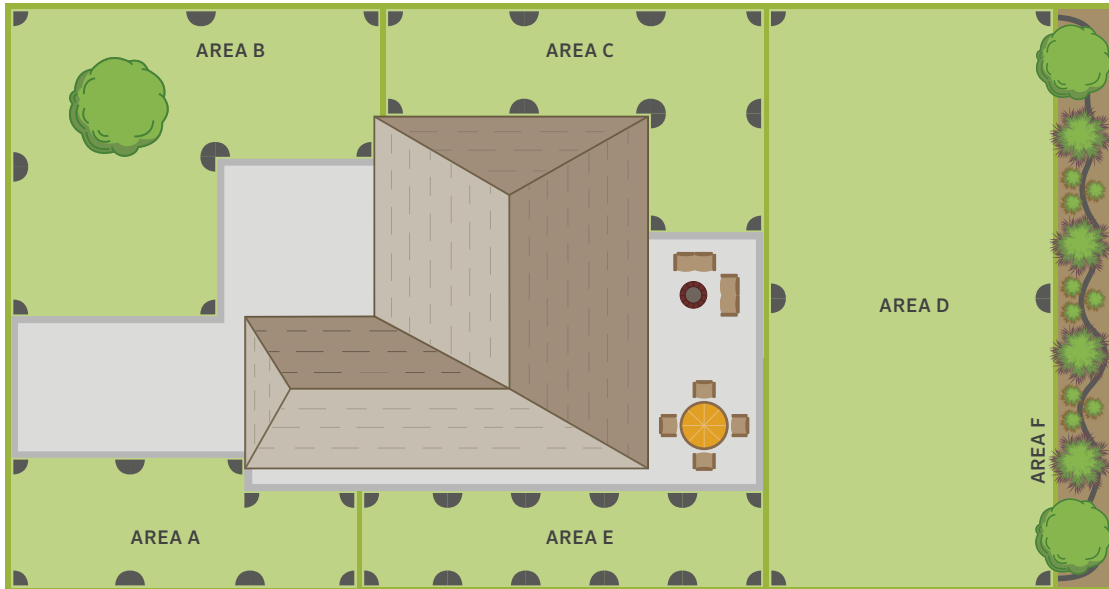

SELECTING SPRINKLERS

Select the Right Product for the Right Area

The graphic below is an example of a layout using Hunter's irrigation products. Area A, B and C would use Sprays and rotating nozzles. Area E would use Sprays and Speciality nozzles. Area D is a large area and would benefit from the use of the PGP Ultra®. Area F should use micro irrigation product dependent on plant type and density.



VALVES

	PGV	PGV JAR-TOP	ICV	DRIP ZONE CONTROL KITS
				
Flow (GPM)	0.2-40	0.2-40	0.1-300	0.5-60
Pressure Regulation	20-150 PSI	20-150 PSI	20-220 PSI	20-120 PSI

MICRO IRRIGATION

	ECO-MAT	ECO-WRAP	PLD	PSE	RZWS	MICRO SPRAYS
						
Application	Sub-Surface	Sub-Surface	On-Surface	Directly at plant	Directly at the root zone	Accurate area watering
Flow	0.6 GPH	0.6 GPH	0.4, 0.6, 1.0 GPH	0-28.6 GPH	0.25 or 0.5 GPH	0-28.6 GPH
Throw Diameter	—	—	—	—	—	0-23 ft
Inlet Type	16 mm/17 mm	16 mm/17 mm	16 mm/17 mm	Self-piercing barb, 10/32" thread, 1/2" female thread	1/2" male threaded	10/32" threaded/barbed

DRAW SPRINKLER HEAD LOCATION

Draw Sprinkler Head Locations

Decide where you will be installing large area sprinklers and where you will be installing small area sprinklers. Large area sprinklers should be 25' to 40' apart. Small area sprinklers should be 8' to 17' apart. This spacing will allow spray patterns to overlap and assure even water distribution. Do not mix sprinkler types within one area. Do not place sprinkler heads too far apart; stay within specifications listed on the Sprinkler Performance Charts which may be found in the Hunter Product Catalog. Spacing is determined by the size of the area the sprinkler is serving. Additionally, a sprinkler should be spaced so that it will spray both the head next to it and the head across from it. Working with one area at a time, start placing sprinkler heads:

Step 1

The critical points on a plan are the corners. Draw a quarter pattern sprinkler in each corner. Using a compass, draw an arc showing the sprinkler's watering pattern.

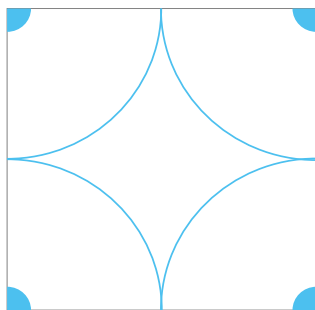

Step 2

If the quarter heads will not spray each other (head-to-head spacing), place heads along the perimeters. Draw these sprinklers' watering patterns.

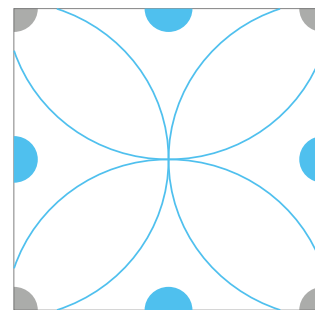

Step 3

Now look to see if the perimeter heads will be spraying across the area to the heads on the other side. If they do not, add full circle heads in the middle. An easy way to locate these heads is to draw perpendicular grid lines from one perimeter head to another. Again, using the compass, draw an arc showing this sprinkler's watering pattern to make sure there is complete coverage.

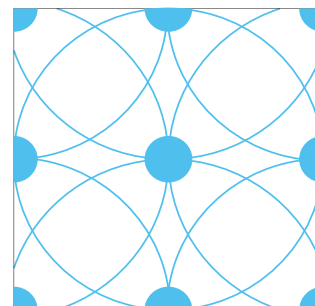
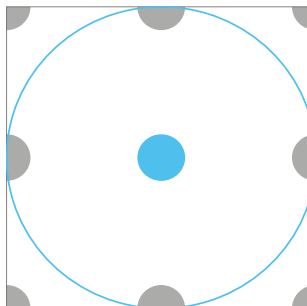

Curved Areas

Convert curved areas to a series of straight lines; place sprinklers the same as you would in square or rectangular areas. Adjustable arc nozzles on spray heads work very well in curved areas.

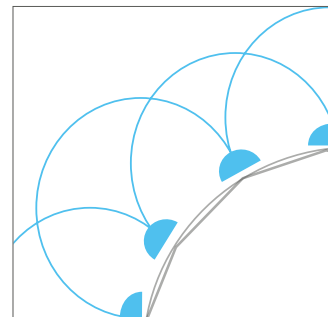
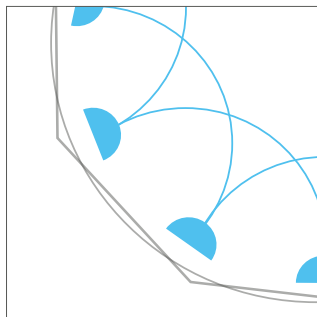

CHECK WITH LOCAL AGENCIES

- To find out if a permit is required before installing a sprinkler system.
- To determine where gas, telephone and other utility lines are buried.
- To find out which type of backflow preventer is required in your area.

SPRINKLER ZONES

Divide Sprinklers Into Zones

Unless you have a very small yard, you probably do not have enough water capacity to irrigate the entire yard at once. Many areas will require more water than the residence has available (system design capacity). Consider the dividing lines based on sun exposure and plant type/watering needs to control the amount of water applied in each area or hydro-zone.

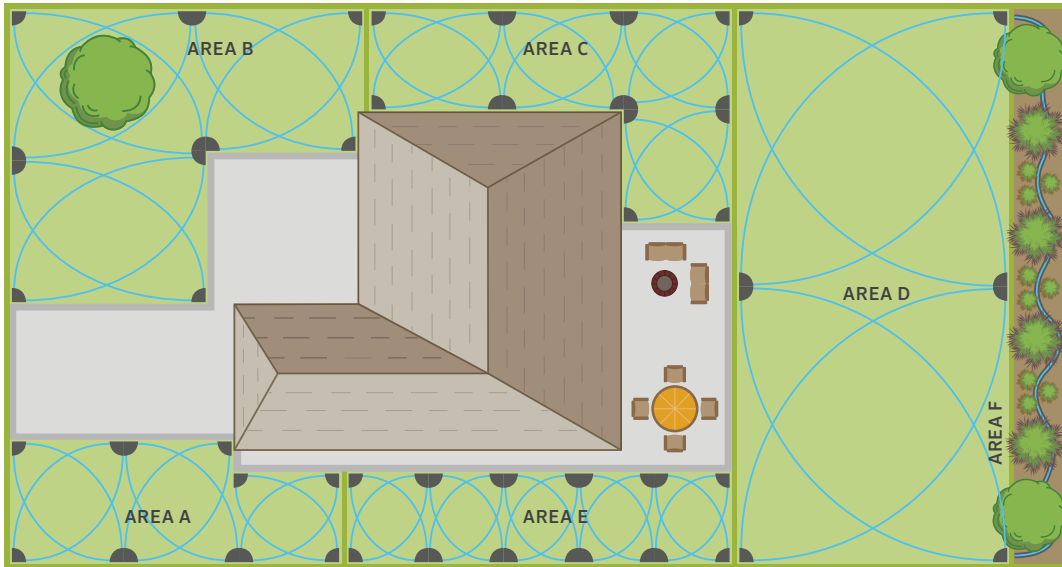

Indicate Zones

You will need to section the yard into “zones.” Dividing the area into zones is an easy process. Beginning with area A:

1. Refer back to the working pressure entered on page 4. This is the pressure you will need to use when determining sprinkler spacing and GPM requirements listed in the Sprinkler Performance Charts.
2. Write the individual sprinkler’s GPM next to each sprinkler head in the area. Use the Sprinkler Performance Charts in the Hunter Product Catalog.
3. Add up all of those numbers and divide the sum by the total GPM (system design capacity) available.
4. If the total number of zones is not a whole number, round the number up to establish how many zones there will be (1.2 zones becomes 2 zones). This is the total number of valves needed for the sprinklers in that area or hydro-zone.
5. Now that you know how many zones the area will have, divide up the sprinklers so that each zone in the area will have approximately the same GPM. Do not place too many heads on the same zone; stay within the system’s design capacity.
6. Draw and label the zone valves for this area, i.e. Zone 1, Zone 2, etc. (As seen on page 10).
7. Draw sprinkler head locations and divide sprinklers into zones for all areas.

$$\frac{\text{Total GPM of all heads in one area}}{\text{Design capacity in GPM (from page 4)}} = \text{Number of zones in this area}$$

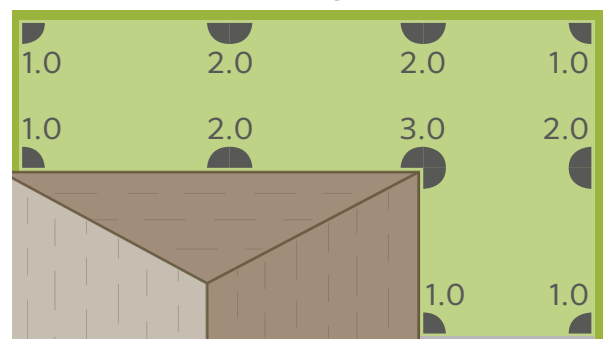

Area C = 16 GPM PGJ mid-range rotors

AREA CAPACITY EXAMPLE

Area	Area GPM	÷	Design Capacity	=	Round up for Number of Zones
A	4.68	÷	13	=	1
B	12.00	÷	13	=	1
C	16.00	÷	13	=	2
D	16.00	÷	13	=	2
E	7.80	÷	13	=	1

VALVES AND PIPES

Locate Valves - Layout and Size Pipes

Every zone on the plot plan must have its own valve. The valve controls the on-off flow of water to a sprinkler zone. Indicate one control valve for each zone and then group the valves together in an assembly called a valve manifold. Determine where you want the valve manifold for each area. You may want a manifold in the front yard and one in the back yard, or you may want more locations. Manifold placement is entirely up to you. We recommend placing the manifold in an accessible spot for easy maintenance. Place the manifold close to the area the valves will serve, but where you will not be sprayed when activating the system manually.

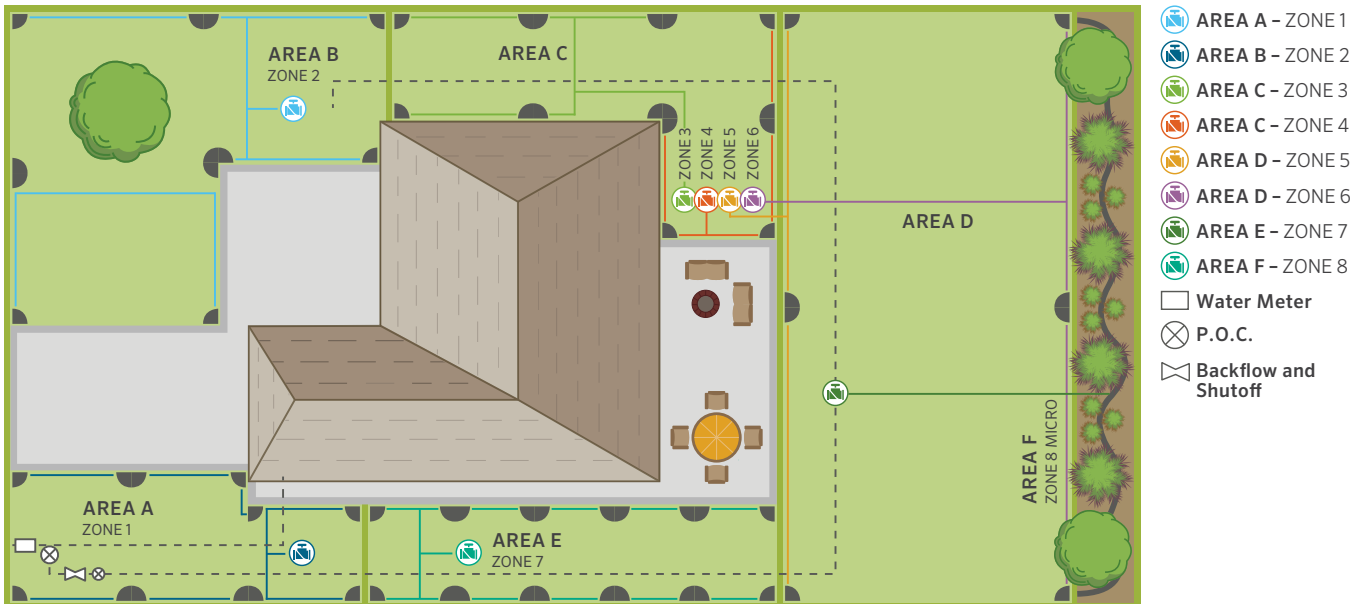

Lateral Line

The two most common types of pipe used in sprinkler systems are polyvinyl chloride (PVC) and polyethylene (Poly). Check with your local Hunter dealer to find out which type of pipe is used in your area.

1. Draw a line connecting all of the sprinkler heads in each separate zone. Follow the example in the illustration on this page and draw the most direct route with the fewest turns or changes of direction as possible.
2. Draw a line from the sprinkler line to the zone valve. This should be the most direct line possible.
3. Begin sizing the pipe. Start at the head farthest from the zone valve. The pipe connecting the last head to the second to last head should be $\frac{3}{4}$ ".
4. Add the GPM requirements of those two heads together to size the next pipe.
5. Add the GPM requirements of the next head to the previous total.
6. Continue to do this until you get to the zone valve.
7. Repeat Steps 1 through 6 for each zone.

PIPE SIZING CHART			
Maximum Flow Rates for Sprinkler Lines			
Pipe Sizes	PVC Thick Wall	PVC Thin Wall	Polyethylene Pipe
$\frac{3}{4}$ "	8 GPM	10 GPM	8 GPM
1"	13 GPM	16 GPM	13 GPM
$1\frac{1}{4}$ "	22 GPM	26 GPM	22 GPM

See Pipe Sizing Illustration on page 19

Connecting Sprinklers with PVC or Poly Pipe

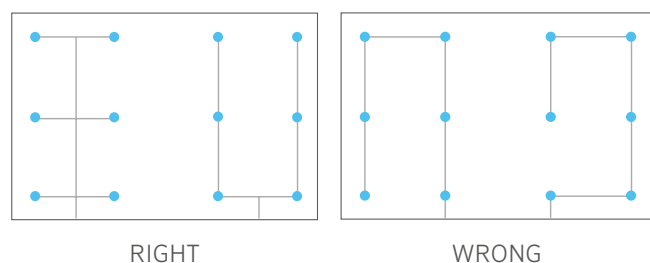

POINT OF CONNECTION

Main Line

1. Determine the location for the system point of connection (P.O.C.). It should be between the water meter and any pressure regulator on the structure.
2. Draw a line connecting all the manifolds together, and then draw a line connecting this line to the P.O.C.
3. The main line should generally be one pipe size larger than the largest lateral line.

Point Of Connection

Non-Freezing Climates

Use a brass compression tee to hook your sprinkler system to the household water supply line. You may hook up to copper, PVC, or galvanized iron service lines without having to solder or thread any pipe. Most areas require some type of backflow preventer to protect drinking water. Copper pipe may be required between the P.O.C. and the backflow preventer. Always check the local building code or with the local permitting agency for the requirements in your area.

Freezing Climates

If the installation is in a freezing climate and the P.O.C. is in the basement, install a boiler drain immediately after the gate valve/ball valve to drain the water in the pipe between the P.O.C. and the backflow preventer in the winter. Install a T with a riser and a threaded cap after the backflow preventer. This will be used when blowing out the system before the first deep freeze of winter.

Review Design

The design process is now complete. Check to make sure you have placed sprinklers in all areas. Also, review the pipe layout to be sure you have sized the pipe correctly. You are now ready to begin installing the system.

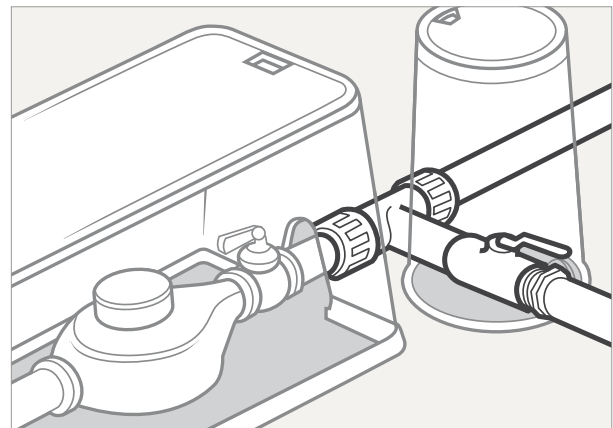

P.O.C. Non-Freezing: Use a brass compression tee to connect your sprinkler system to the household water supply.

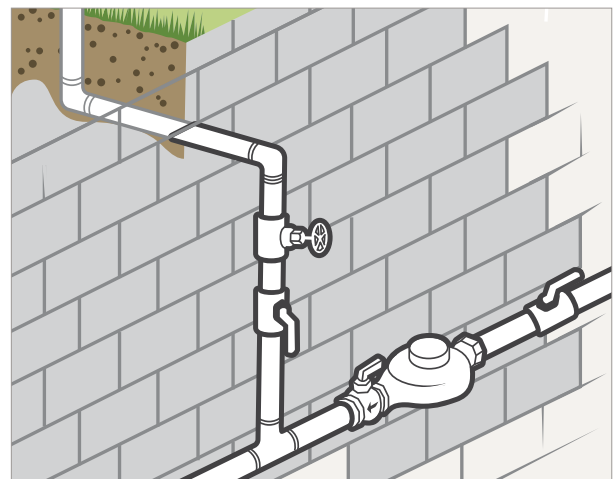

P.O.C. Freezing Climate: If the P.O.C. is in the basement, install a boiler drain immediately after the gate valve to drain the system before the first big freeze.



CHECK WITH LOCAL ORDINANCES

Most professional installers recommend PVC pipe for the constant pressure line from the backflow preventer to the zone control valves. However, some communities require copper. Check local ordinances before laying out your system.

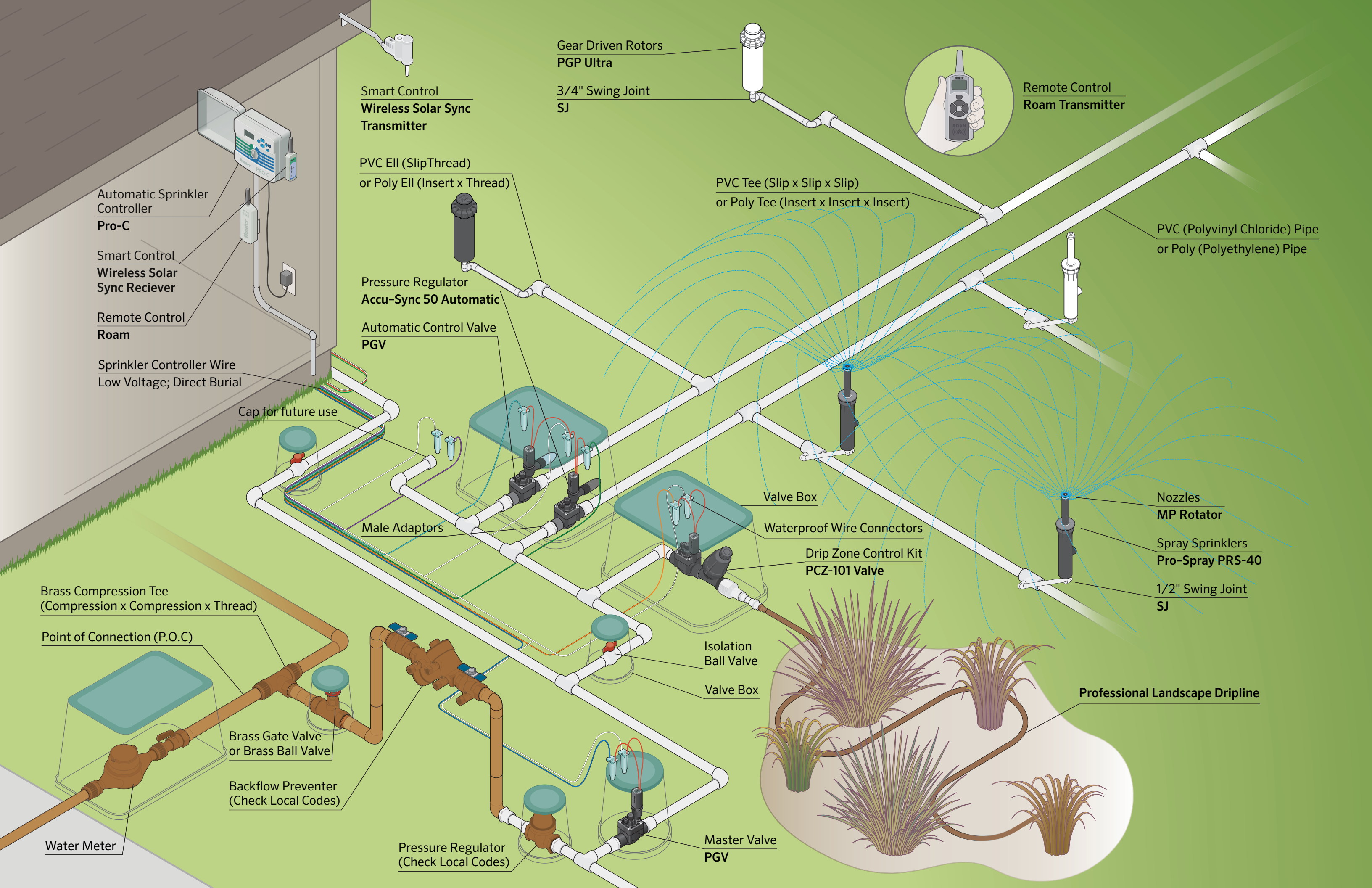

Gear Driven Rotors
PGP Ultra
3/4" Swing Joint
SJ



Remote Control
Roam Transmitter

Smart Control
Wireless Solar Sync
Transmitter

PVC EII (SlipThread)
or Poly EII (Insert x Thread)

PVC Tee (Slip x Slip x Slip)
or Poly Tee (Insert x Insert x Insert)

PVC (Polyvinyl Chloride) Pipe
or Poly (Polyethylene) Pipe

Automatic Sprinkler
Controller
Pro-C

Smart Control
Wireless Solar
Sync Reciever

Remote Control
Roam

Sprinkler Controller Wire
Low Voltage; Direct Burial

Pressure Regulator
Accu-Sync 50 Automatic

Automatic Control Valve
PGV

Cap for future use

Valve Box

Nozzles
MP Rotator
Spray Sprinklers
Pro-Spray PRS-40

Male Adaptors

Waterproof Wire Connectors

Drip Zone Control Kit
PCZ-101 Valve

1/2" Swing Joint
SJ

Brass Compression Tee
(Compression x Compression x Thread)

Point of Connection (P.O.C)

Isolation
Ball Valve

Valve Box

Professional Landscape Dripline

Brass Gate Valve
or Brass Ball Valve

Backflow Preventer
(Check Local Codes)

Water Meter

Pressure Regulator
(Check Local Codes)

Master Valve
PGV

SYSTEM INSTALLATION

Making the Point of Connection

1. Refer to the Point Of Connection (P.O.C.) detail on the Sprinkler System Overview. *See pages 12 to 13.*
2. Turn off the water supply to the residence.
3. Dig a hole to expose the supply line.
4. Cut an appropriate piece out of the supply line, slip the compression tee onto the pipe, and tighten the compression nuts.
5. Install the brass nipple and shut off valve.
6. Install the valve box for easy access to the shut off valve.
7. Turn the water back on to the residence.

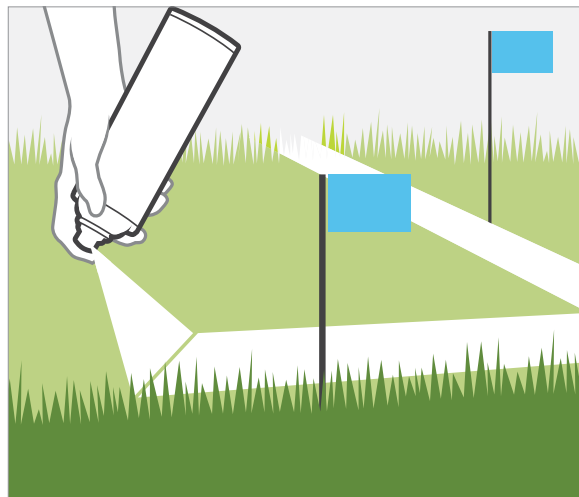

Figure 1

Installing the Main Line

1. Using marking spray paint and small flags, indicate the pipe lines from the P.O.C. to the valve manifold locations. Mark the layout of the irrigation system *Figure 1.*
2. On existing lawns, lay down a plastic tarp alongside the marked trench about 2' away from where the pipe will be placed.
3. Remove the sod by cutting a strip about 12" wide and 1½" to 2" deep using a flat shovel. Roll up the sod and place the sod and dirt on the plastic tarp.
4. Trenching: Check local codes. If there are no established local codes for sprinkler main line depth in your area, trench 10" to 12" deep. Trench 6" to 8" for lateral lines. Trenching can be done by hand or with a trencher. Trenchers are available at most equipment rental yards *Figure 2.*
5. Installing Pipe Under a Walkway or Driveway: Jetting Method —Using a pipe-to-hose threaded adapter, connect one end of the pipe to a garden hose and attach a small stream hose nozzle to the other end. Turn the water on and jet under the concrete *Figure 3.*
6. Install the backflow preventer according to local codes.
7. Installing Pipe: Lay out pipe and fittings near the trenches according to how they will be installed. Be careful not to get dirt or debris in the pipe.
8. Beginning with the P.O.C. (or backflow preventer if applicable), measure, cut and install the pipe, working your way to the last manifold or stub-out. *See Sprinkler System Overview on pages 12 to 13.*

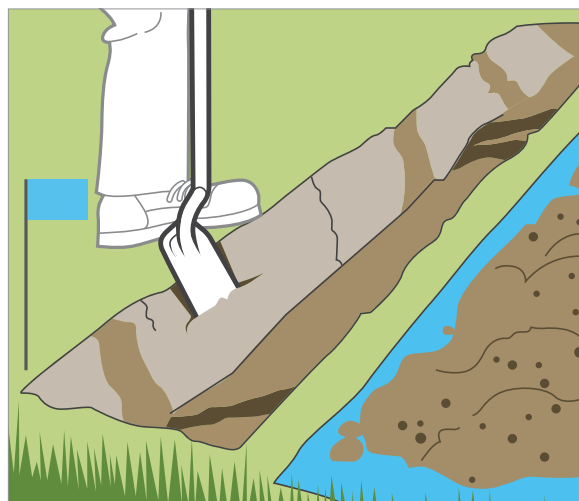

Figure 2



Figure 3

SYSTEM INSTALLATION

Installing the Valve Manifolds

1. Refer to the valve manifold detail on the Sprinkler System Overview.
2. Maintain at least a 6" clearance between valves for future maintenance.
3. Provide a 3" long or longer capped stub-out for future additions.
4. Install the valve manifolds onto the main line.

Installing the Lateral Lines

If you can only devote a day or two at a time to installing this system, and the installation is in an area that is currently landscaped, lay out all zones and install one zone at a time using the following steps:

1. Lay Out System: Using the plot plan and small sprinkler flags, mark the location of the sprinklers and their zone valve. Make adjustments as necessary for complete head-to-head coverage. If it appears that you will need to revise the plan (add a head), recheck the GPM numbers to make sure you are within the system's design capacity.
See page 5.
2. Using marking spray paint, mark the locations for the lateral lines.
3. Trenching: Check local codes. If there are no established codes for sprinkler lateral line depth in your area, dig the trenches 6" to 8" deep. If you are installing poly pipe, you may want to use a pipe puller, which may be available at your local rental yard.
4. Installing Pipe: Lay out pipe and fittings at the side of the trenches according to how they will be installed. Be careful not to get dirt and debris inside the pipe.

Assembling PVC:

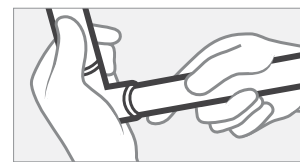
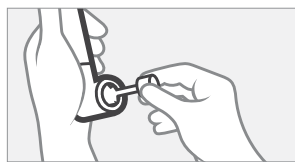

1. Place solvent on inside of fitting and outside of pipe.
2. Slip pipe into fitting and wipe off excess solvent.

Assembling Poly Pipe:

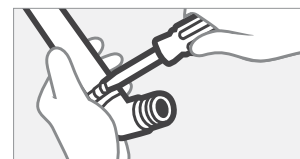
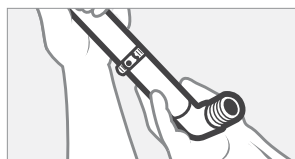

1. Place clamp over pipe, then insert barb fitting.
2. Tighten clamp around pipe and fitting.

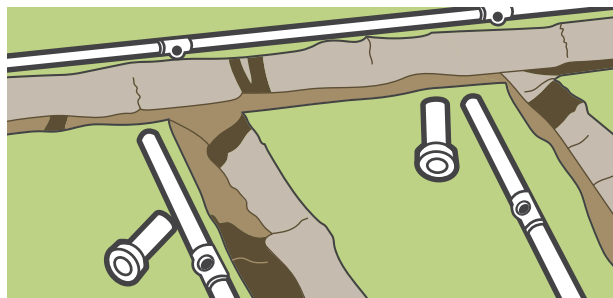

Lay out the pipes and sprinklers near the trenches where they will be installed.

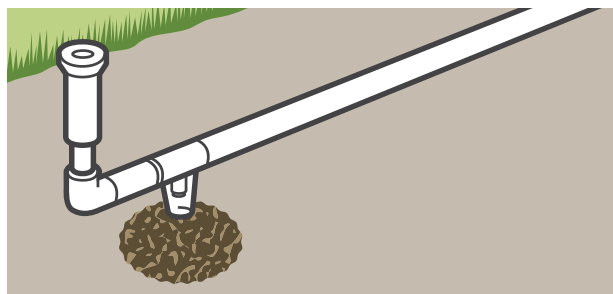

Automatic Drain Valve Installation for Freezing Climates: Locate the drain valves at the low points in each zone.



PREVENT CLOGS IN YOUR SYSTEM

Use pipe cutters to cut your PVC sprinkler pipe. Any plastic burrs left behind when using a hacksaw can clog up your sprinkler heads. When using pipe cutters, turn the PVC pipe $\frac{1}{8}$ to $\frac{1}{4}$ turn while applying pressure with the cutters. This reduces the risk of breaking the PVC.

SYSTEM INSTALLATION

Installing the Controller

1. Decide where you would like to install the controller. Most residential controllers should be installed indoors, i.e. the garage. Follow the installation instructions that come with the controller. You will need a 115 V electrical outlet to plug in the low voltage transformer.
2. Use color-coded irrigation wire to connect the valves to the controller. The total number of wires you need is one for each of the valves, plus one common wire. If you are wiring a 5-zone system, purchase a combination of wires with at least 6 total wires long enough to reach from your controller to the farthest valve.
3. Installing Wire: Lay the wire in the trench from the controller to the valve manifolds. It is best to protect the wire from future digging by installing it directly beneath the pipe where possible. Leave an expansion loop of wire at each change of direction. The loop will ensure that the wires will not be installed too tightly and will reduce the possibility of stretching.
4. Connect the wires to the valves with waterproof connectors. You will need one wire for each valve, plus one common wire which will be connected to one of the wires on all of the valves.

Installing Sprinkler Heads

1. Install all the heads but the last head on a run. Leave the last one(s) off for proper flushing.
2. Flushing System: Turn on the zone manually at the valve. Allow the water to flush out any dirt which may have entered the system. Flush the system even if you are sure nothing got in during installation. When you are certain that the water is clean, turn the zone valve off and install the remaining heads.
3. Checking for Proper Coverage: Turn the zone on at the controller. By activating the controller, you are making sure that the wire and wire connectors are operating properly. Adjust the sprinklers and check for coverage.

Backfilling

1. Do not directly bury the valves. Install a valve box for easy access to valves. Wait until you are backfilling the trench to set the valve box.
2. Make sure there are no rocks directly next to the pipe. Backfill one-third to one-half of the depth of the trench at a time, compacting the dirt as you go. Make sure to allow space for the extra dirt on the sod when setting the sprinkler heads and valve boxes.

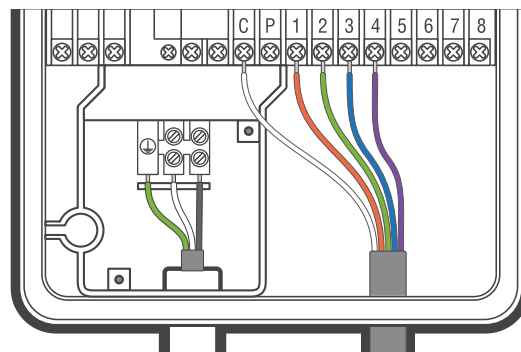

Use color-coded irrigation wire to connect the valves to the controller. You will need one wire for each valve, plus one common wire.



The Hunter ROAM Remote Control Kit saves time during installation and routine system maintenance. The receiver (right) plugs into the Controller Connection Kit and the transmitter (left) activates the sprinklers within a 1000' range. The user can manually run any zone without resetting the controller.



BUILD FOR EXPANSION

When deciding how many sprinkler wires you need, add at least two extra wires for each valve manifold for future expansion. It is much easier to install them now than later after the landscape has grown in.

SYSTEM INSTALLATION

Weather-Based Sensors

Weather-based sensors are available in a variety of sensor types and combinations including rain, freeze and ET (Evapotranspiration) based sensors. Rain and Freeze sensors simply stop or prevent irrigation in the event of rainfall or freeze conditions. ET sensors calculate the amount of water needed by the plant material and adjust run times automatically based on current weather conditions.

Mounting Suggestions

1. Rain sensors should be installed where they can receive direct rainfall such as on the edge of a roof, a rain gutter, or on a fence post. Make sure they are not located under trees or other plant material and they are not getting wet within the sprinkler spray pattern.
2. Freeze sensors will stop or prevent irrigation at or below 32 degrees Fahrenheit. The sensor will reactivate the system above 37°F.
3. Weather-based ET sensors are required to receive as many hours of direct sunlight during the day and throughout the year as possible.

Communication Options

1. Wired communication – sensors are attached to the controller sensor inputs directly with two wires from the sensor. Care should be taken to carefully install and attach the wire path without damaging the wire.
2. Wireless communication – sensors have a battery-operated transmitter within the sensor that sends data to the receiver attached to the controller. Wireless communication affords more options for mounting the sensor but ensure you have reception from the proposed mounting location. Also, be aware of high voltage sources of interference that may cause difficulty in reception. Ensure you test the sensor/transmitter at the mounting location for proper reception to the receiver to avoid connectivity difficulties in the future.

Solar Sync®

ET weather sensor with rain and freeze shutdown.



Rain-Clik®

Shuts down irrigation during a rain or freeze event.



Mini-Clik

Shuts down irrigation at desired rain fall amount.



Soil-Clik™

Responds as a shut off device when the user selected soil moisture threshold is surpassed.



MATERIALS LIST

Point of Connection

Using your plot plan and the check lists below, do a take-off to determine your Materials List. If you are unsure what a part is called, check the Sprinkler System Overview. Use colored pencils and as you count or measure each component, mark the plan and write the item down here on this Materials List. Make sure to list everything on your plan.

Detail and list the materials needed by size. Check the backflow prevention requirements for your area and record the materials needed.

POINT OF CONNECTION

List all the items needed for the system's point of connection.

Brass Compression Tee (compression x compression x thread)	
Brass Gate Valve or Brass Ball Valve	
Valve Box	

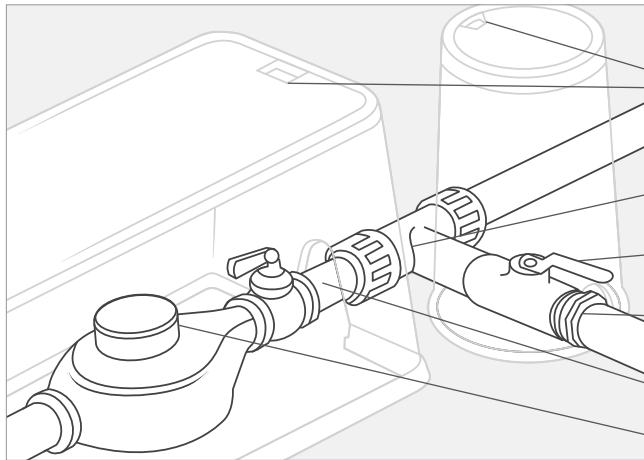

Exterior Point of Connection - Non Freezing

- Valve box square or round
- Brass compression tee
(compression x compression x thread)
- Brass gate valve or brass ball valve
- Male adapter
- Point of connection (P.O.C.)
- Water meter

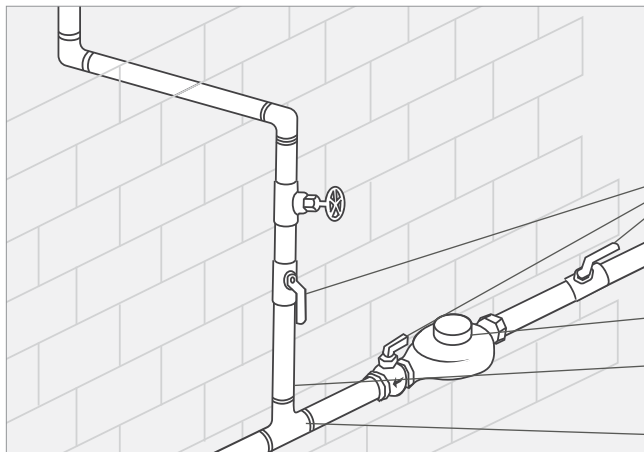

Interior Point of Connection - Freezing Climates

- Brass gate valve or brass ball valve
- Water meter
- Point of connection (P.O.C.)
- Brass compression tee
(compression x compression x thread)

MATERIALS LIST

Pipes

Measure and list pipe by size. Be sure to add a little additional pipe for waste. Count and list the number of main line and lateral line fittings by size and type.

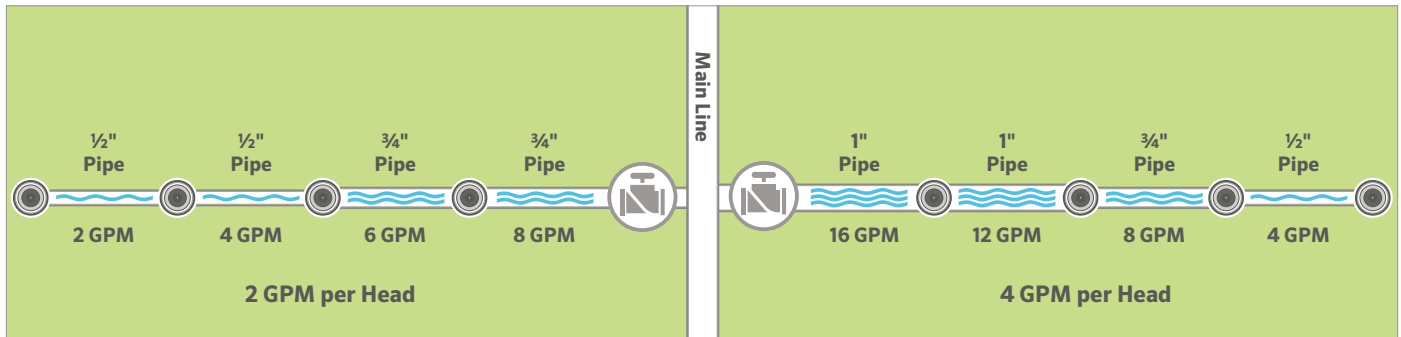

FITTINGS (Calculate the length of pipe and number of fittings required)						
PVC (slip x slip x slip)		3/4"	1"	1 1/4"	Poly (compression or barbed insert fittings)	
TEE 	S x S x S S x S x 1/2" T S x S x 3/4" T				i x i x i i x i x 1/2" T i x i x 3/4" T	TEE
ELBOW 	90° x S x S 90° S x 3/4" T 90° S x 1" T 45° x S x S				90° x i x i 90° i x 3/4" T 90° i x 1" T 45° x i x i	ELBOW
REDUCER BRUSHING 	1" S x 3/4" S 1 1/4" S x 1" S				1" i x 3/4" i 1 1/4" i x 1" i	REDUCER COUPLING
REDUCING TEE 	S x S x S				i x i x i	REDUCING TEE
MALE ADAPTERS 	S x T				i x T	MALE ADAPTERS
COUPLING 	S x S				i x i	COUPLING

S = Slip Fitting T = Threaded Fitting i = Compression or Insert Connection

! WATCH OUT FOR HAIRLINE CRACKS

Never drop a PVC pipe. If it is dropped and hits a rock or concrete the pipe could shatter and send tiny sharp pieces flying. Even if the pipe does not break, it could get a hairline crack and later burst under normal water pressure. This can also happen if the pipe is allowed to slap together while being carried.

MATERIALS LIST

Control Valves

Count the number of valves by size. Using the valve detail, list the materials needed.

Accessories

Waterproof wire connectors ensure a safe and durable connection of electrical equipment.

Accu-Sync is a simple pressure regulator designed to be compatible with all of Hunter's control valves. Regulating pressure saves water and extends the life of the irrigation system.

AUTOMATIC CONTROL VALVES

List all the items needed to build the valve manifolds.

	Size	Quantity
Valve Box		
Waterproof Wire Connectors		
Pressure Regulators		
PGV Valves	1"	
Male Adapters		

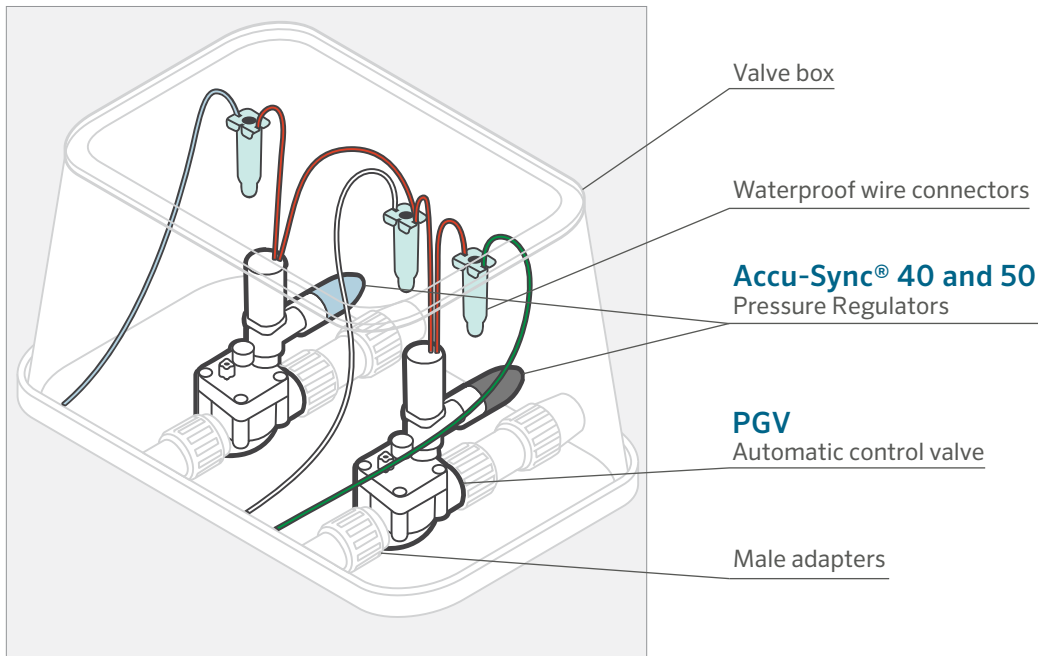

MATERIALS LIST

Controller

The number of valves will determine the size of the controller required. You will need one controller station for each valve. Measure the wire run from the controller to the farthest valve.

Note: Use color-coded, multi-conductor low voltage wire. You will need one wire for each valve, plus one common wire which will be connected to all of the valves. An automatic controller stores information on what days to water, what time to start watering and how long each zone will run

CONTROLLER	
Pro-C® Controller	_____ Stations
ROAM Remote Control	
18 Gauge, Direct Burial Wire with Number of Strands _____	_____ Feet
Solar Sync®	

Example:

On your plot plan, if you need 8" of wire and your scale is 1"=10', then you will need 80' of wire (8 x 10' = 80'). Do not forget to add a little extra wire at the valve so that it makes it easier to work on the wire connectors, and enough wire to go up the wall to connect to the controller.

Weather-Based Sensors

Select the weather-based sensor that best suits your needs based on your site conditions.

WEATHER-BASED SENSORS	
Select the weather sensor that best suits your needs based on your site conditions.	
Mini-Clik	
Rain-Clik®	
Solar-Sync®	
Soil Clik®	

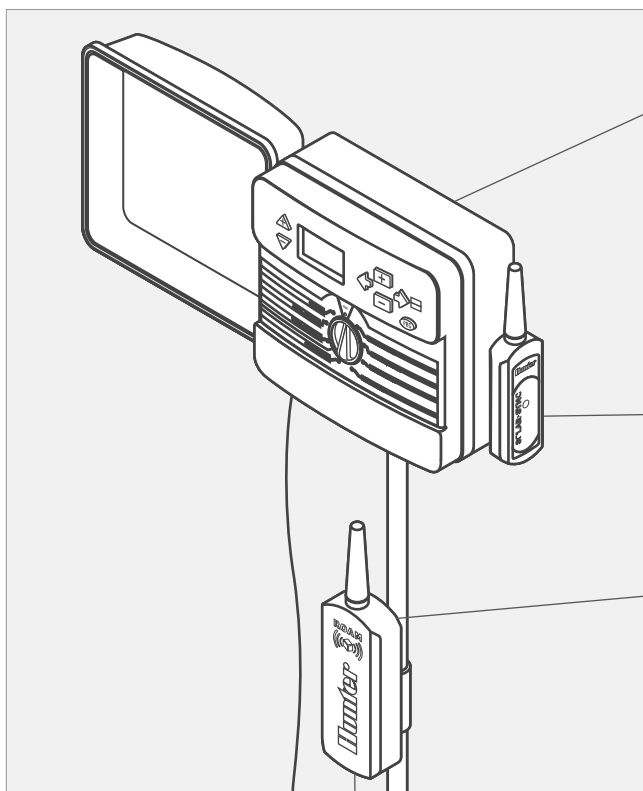

Pro-C
Automatic sprinkler controller

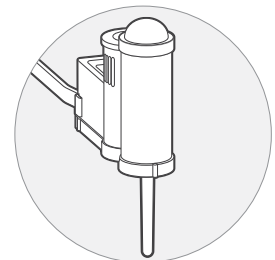

Solar Sync
Weather-based sensor and Wireless Solar Sync Receiver.

ROAM
Remote control

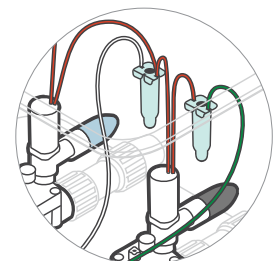

Low voltage sprinkler controller wire and PVC conduit for low voltage wire (optional).

MATERIALS LIST

SPRINKLERS – GEAR DRIVEN ROTORS

Count all of the sprinklers on your plan and list here:

POP-UP, LAWN	Quantity
PGJ ½" inlet	
PGP® ¾" inlet	
I-20 ¾" Inlet	
SHRUB – RISER MOUNTED OR HIGH POP-UP	
PGJ ½" inlet	
PGP® ¾" inlet	
I-20 ¾" Inlet	

SPRAY SPRINKLERS WITH ADJUSTABLE ARC NOZZLES

POP-UP, LAWN	Quantity
Pro-Spray®/PRS30/PRS40 ½" inlet	
PS Ultra ½" inlet	
SHRUB – RISER MOUNTED OR HIGH POP-UP	
Pro-Spray ½" inlet	

NOZZLES

Select the type of nozzles and the quantity that is needed:

	Quantity
MP Rotator	
MP Rotator SR Series	
Precision Distribution Control™ Adjustable Nozzles	
Pro Fixed	
Specialty	
Bubblers	

HUNTER SWING JOINTS, PRE-ASSEMBLED

SJ SERIES	Quantity
SJ-506 ½" x 6"	
SJ-512 ½" x 12"	
SJ-7506 ½" x ¾" x 6"	
SJ-7512 ½" x ¾" x 12"	
SJ-712 ¾" x 12"	

SWING JOINT ASSEMBLIES

Count the number of sprinklers required, then determine the quantity of parts needed:

	½" Inlet Sprinkler	Total
½" Marlex Street Ell	x 3 =	
½" x 8" schedule 80 nipple for Pop-up	x 1 =	
½" x 14" (or ___") nipple for Shrub	x 1 =	
	¾" Inlet Sprinkler	Total
¾" Marlex Street Ell	x 3 =	
¾" x 8" schedule 80 nipple for Pop-up	x 1 =	
¾" x 14" (or ___") nipple for Shrub	x 1 =	

MATERIALS LIST

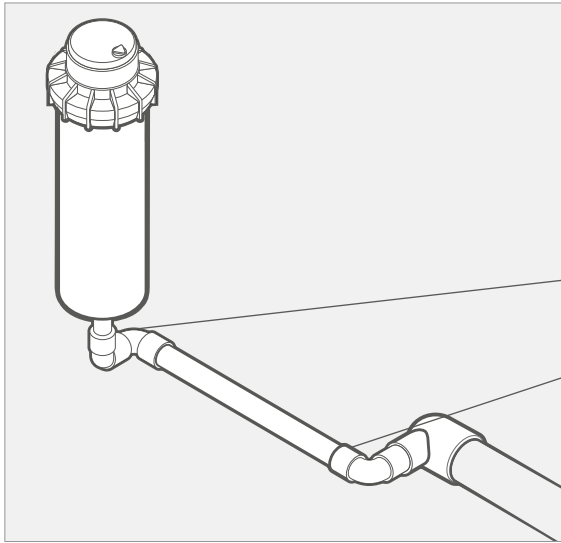

PGP® Ultra

Use a pre-assembled Hunter swing joint (SJ series) or assemble these components.

(2) 3/4" Street elbows (thread x thread)

3/4" Nipple

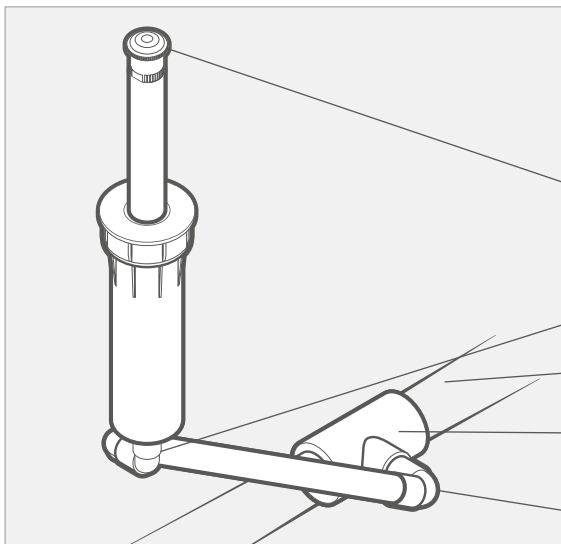

MP Rotator®

Use a pre-assembled Hunter **swing joint** (SJ series) or assemble these components

Nozzles
Adjustable arc fan spray
or MP Rotator

1/2" Nipple

PVC or Poly pipe

Reducing tee

(3) 1/2" Street elbows
(thread x thread)

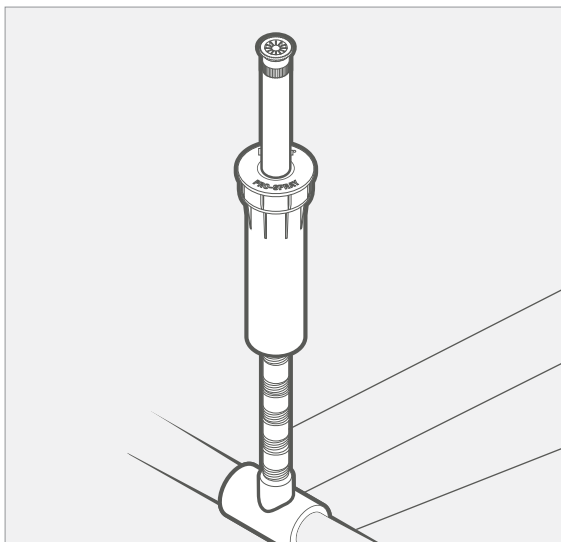

Pro-Spray®

Alternate installation method:
Flexible or "Cut-off" riser

Flexible or
"cut-off" riser

Reducing tee

PVC or
Poly pipe

WATERING GUIDELINES

Application Rates

Watering application rates should vary with different types of plants, soils, and climates. New lawn must be kept moist, and newly-transplanted shrubs must be watered every day or two. Established plants will need deeper, less frequent watering. The following guidelines will get you started.

Watering Guidelines

1. Do not operate more than one valve at a time.
2. Water early in the morning when it is least windy and pressure is the greatest. Early morning watering will also reduce water evaporation. Watering in the early evening is not recommended. A lawn is more likely to get diseases when wet for a long duration, especially overnight during the summer. Watering on a hot summer day may also burn the plants.
3. In most areas, lawns require 1½" to 2" of water per week in the hottest months. Hot and arid areas may require more.
4. Manually activate your system at regular intervals to make sure everything is operating correctly. Check and clean sprinklers to ensure proper functioning.

Freezing Areas

In freezing climates, turn off the controller, close the main sprinkler shut-off valve, drain all the water from the system, and blow any remaining water out of the system before the first freeze. If you are unfamiliar with the correct procedure for blowing out a sprinkler system, contact your local Hunter dealer for advice or a referral. Consider using a weather-based sensor containing the freeze shut off capability.

Choosing Rotary Sprinkler Nozzles

When designing an irrigation system, it is important to ensure that the precipitation rate (rate at which water is applied) is even over each zone of coverage. "Matched precipitation" is accomplished by selecting the appropriate nozzles, or zoning together sprinklers with the same precipitation rate. The two criteria to consider are a sprinkler's flow rate and arc of coverage. The illustration (to the right) depicts three different sprinkler heads with matched precipitation rates. In each case, 1 gallon per minute (GPM) is applied to each quarter circle and precipitation is therefore matched.

WATERING GUIDELINES



Cool, non-arid climates – Apply 1" of water per week.
Hot, arid climates – Apply 2" of water per week.

Clay soils, fine particles, absorbs water slowly	Program the controller with shorter run times; increase the number of start time cycles per day; decrease the number of water days per week.
Loam soils, medium-sized particles, average absorption rate	Program the controller with longer run times and fewer start time cycles per week.
Sandy soils, larger particles, absorbs water quite rapidly	Program the controller with longer run times; decrease the number of cycles per day; increase the number of water days per week.

SPRINKLER RUN TIME SCHEDULE SPREAD OVER 7 DAYS

Water To Apply Each Week	Spray Sprinklers	PGJ Rotors	PGP® Rotors	I-20 Rotors
1"	40 min.	130 min.	150 min.	150 min.
2"	80 min.	260 min.	300 min.	300 min.

ROTARY SPRINKLER NOZZLES

Arc of Coverage	Pattern	Flow Rate
90°		1 GPM
180°		2 GPM
360°		4 GPM

PARTS ORDERING LIST

NOZZLES

Select the type of nozzles and the quantity that is needed:













	Quantity
MP Rotator	
MP Rotator SR Series	
Precision Distribution Control™ Adjustable Nozzles	
Pro Fixed	
Specialty	
Bubblers	

POINT OF CONNECTION

List all the items needed for the system's point of connection.

Brass Compression Tee (compression x compression x thread)	
Brass Gate Valve or Brass Ball Valve	
Valve Box	

FITTINGS (Calculate the length of pipe and number of fittings required)

PVC (slip x slip x slip)		¾"	1"	1¼"	Poly (compression or barbed insert fittings)	
TEE 	S x S x S S x S x ½" T S x S x ¾" T				i x i i x i ½" T i x i ¾" T	TEE 
ELBOW 	90° x S x S 90° S x ¾" T 90° S x 1" T 45° x S x S				90° x i 90° i x ¾" T 90° i x 1" T 45° x i	ELBOW 
REDUCER BRUSHING 	1" S x ¾" S 1¼" S x 1" S				1" i x ¾" i 1¼" i x 1" i	REDUCER COUPLING 
REDUCING TEE 	S x S x S				i x i	REDUCING TEE 
MALE ADAPTERS 	S x T				i x T	MALE ADAPTERS 
COUPLING 	S x S				i x i	COUPLING 

S = Slip Fitting

T = Threaded Fitting

i = Compression or Insert Connection

PARTS ORDERING LIST

SPRINKLERS – GEAR DRIVEN ROTORS

Count all of the sprinklers on your plan and list here:

POP-UP, LAWN	Quantity
PGJ ½" inlet	
PGP® ¾" inlet	
I-20 ¾" Inlet	
SHRUB – RISER MOUNTED OR HIGH POP-UP	
PGJ ½" inlet	
PGP® ¾" inlet	
I-20 ¾" Inlet	

SPRAY SPRINKLERS WITH ADJUSTABLE ARC NOZZLES

POP-UP, LAWN	Quantity
Pro-Spray®/PRS30/PRS40 ½" inlet	
PS Ultra ½" inlet	
SHRUB – RISER MOUNTED OR HIGH POP-UP	
Pro-Spray ½" inlet	

AUTOMATIC CONTROL VALVES

List all the items needed to build the valve manifolds.

	Size	Quantity
PGV Valve	1"	
Valve Box		
Male Adapters		
Waterproof Wire Connectors		

MICRO IRRIGATION

	Quantity
Eco-Mat	
Eco-Wrap	
Professional Landscape Drip (PLD)	
Point Source Emitters	
Root Zone Watering System	
Micro Sprays	

HUNTER SWING JOINTS, PRE-ASSEMBLED

SJ SERIES	Quantity
SJ-506 ½" x 6"	
SJ-512 ½" x 12"	
SJ-7506 ½" x ¾" x 6"	
SJ-7512 ½" x ¾" x 12"	
SJ-712 ¾" x 12"	

SWING JOINT ASSEMBLIES

Count the number of sprinklers required, then determine the quantity of parts needed:

	½" Inlet Sprinkler	Total
½" Marlex Street Ell	x 3 =	
½" x 8" schedule 80 nipple for Pop-up	x 1 =	
½" x 14" (or ___") nipple for Shrub	x 1 =	
	¾" Inlet Sprinkler	Total
¾" Marlex Street Ell	x 3 =	
¾" x 8" schedule 80 nipple for Pop-up	x 1 =	
¾" x 14" (or ___") nipple for Shrub	x 1 =	

CONTROLLER

X-Core Controller	_____ Stations
Roam	
18 AWG Direct Burial Wire with Number of Strands _____	_____ Feet
Solar Sync®	

WEATHER-BASED SENSORS

Select the weather sensor that best suits your needs based on your site conditions.

	Quantity
Mini-Click	
Rain-Click®	
Solar-Sync®	
Soil Click™	

GLOSSARY OF TERMS

Arc – Circular pattern a sprinkler will rotate or spray.

Backflow Preventer – A device installed between the P.O.C. and the control valves that prevents the backflow of contaminated water into the drinking water. Check with your Hunter dealer or local permitting agency for the device(s) approved for your area.

Check Valve – A small device often installed in the base of a sprinkler that allows water to flow in one direction only and does not open until a pre-set pressure is reached. Is usually used to prevent low head drainage and pooling of water at the bottom of a slope or low areas.

Control Valves – Automatic sprinkler control valves are valves that are activated with a low voltage output from the controller and are connected to the controller by direct burial low voltage wire. A group of control valves located together is called a manifold.

Controller (Timer) – A device that uses low voltage connected via wiring to activate automatic control valves that open and allow water to flow to sprinklers for irrigation. The user sets the individual programs that consist of program start times, stations (zones or valves), run times, and watering days.

Drip Control Zone Kit – A kit that includes a control valve, a filter, and a pressure regulator for drip zones.

Friction Loss – Water flowing through the meter, pipe, valves, and fittings will have considerable drag or friction. When the velocity of water increases, the friction loss increases. When the diameter of the pipe increases, friction loss decreases. Friction loss reduces the available dynamic pressure.

Head-to-Head – This phrase describes the correct placement of spray heads or stream rotors. One sprinkler must be placed so that it will spray another sprinkler (or 50% of the adjusted diameter). This provides for complete coverage and prevents dry spots.

MP Rotator – A high efficiency, low precipitation rate, rotating stream spray nozzle that can be used in place of traditional spray nozzles.

P.O.C. (Point of Connection) – Sprinkler main line tie-in point. A manual shut off valve is usually installed at this point to shut off the irrigation in the event of a pipe break or to perform maintenance on the system.

Poly Pipe – Polyethylene pipe is black, flexible pipe popular in areas that are susceptible to long winter freezes. Insert or compression fittings are used to connect the pipe.

Precipitation Rate – Expressed in inches/hr, precipitation rate is the rate at which water is applied. Matched precipitation means all of the sprinklers in the area are placing about the same amount of water in a given area. Different type of sprinklers should not be installed in the same zone. Large and small area sprinklers may have

similar GPM but the area they cover is not the same and the precipitation rates would be very different.

Pressure – Measured with a pressure gauge and expressed in PSI. Static pressure is the pressure when no water is flowing through a closed system. Dynamic pressure is when the system is open and water is flowing through the pipes.

PVC Pipe – The most common type of pipe in areas with warmer climates. Generally white in color, PVC (polyvinyl chloride) pipe is more rigid than poly pipe and uses PVC solvents to glue the pipe together.

Radius – Distance that the water sprays from the sprinkler.

Rotors – Gear driven sprinklers that deliver a solid stream of water and rotate slowly in a circular pattern, from 15'-46'. Rotors fit into the "large area sprinklers" category.

Sensor – Weather-activated shut-off device.

Shut off valves – Valves used to isolate the irrigation system from the water supply or to isolate sections of the irrigation system for maintenance. The valve may be either a brass gate valve or a brass or plastic ball valve. Care should be used to slowly turn ball valves on or off as they only require ¼ turn to open or close and could cause damage if operated rapidly.

Spray Heads – Sprinklers that emit a fan-type spray of small droplets of water. The heads have a radius of 17' or less. Spray heads fit into the "small area sprinklers" category.

Volume – Expressed in GPM (gallons per minute). Volume is used to describe either the amount of water available or the amount of water used. The available gallons per minute must be known before a sprinkler design can be completed. The total GPM of all the sprinkler heads on one zone should not exceed the available GPM.

Water Hammer – The surging of pressure which occurs when a control valve is suddenly closed. In extreme conditions, this surging will cause pipes to vibrate or create a pounding noise. Water hammer is most commonly caused by fast closing valves or pipes that have been sized too small causing high velocity water flow.

Wire – In an automatic sprinkler system, low voltage direct burial wire is used to connect the automatic control valves to the controller. Color coded, multi-strand sprinkler wire is the most common and has several coated wires together in one protective jacket.

Hunter®

Helping our customers succeed is what drives us. While our passion for innovation and engineering is built into everything we do, it is our commitment to exceptional support that we hope will keep you in the Hunter family of customers for years to come.



Gregory R. Hunter, President of Hunter Industries

Website hunterindustries.com | **Customer Support** 1-800-383-4747 | **Technical Service** 1-800-733-2823

This brochure was printed on Forest Stewardship Council® (FSC®) certified paper with soy inks. The FSC is an international organization established to promote the responsible management of the world's forests.



Printed using
100% Wind
Energy, (RECs)

© 2016 Hunter Industries Incorporated  Please recycle.

LIT-226-US E 1/16

